



# TRANSIT PROTECTION Tyoga

(800) 724-6003  
 Fax: (570) 835-5045  
 PO Box 517  
 Tioga, PA 16946

*Packaging for strength. Shipping for success.*



## Load Securement Solutions and Transit Protection Products

Minimize Damage

Prevent Accidents

Custom Design  
Your Damage  
Prevention Systems

Resolve Loading  
Issues with Prompt  
Personal Service

Train Your Staff  
On Site in Best  
Loading Practices

Licensed manufacturer for:



Call for more  
information  
or a quote  
today!

(800) 724-6003

### Diamond-Corr® Void Filler

**Diamond-Corr®II** (Economy Type)

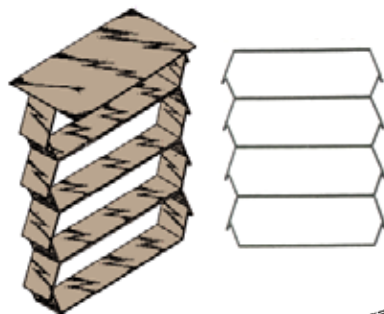

#### Benefits:

- **Diamond-Corr® Void Filler**  
Crosswise void filler to prevent side shifting
- **Diamond-Corr®II**  
Economy crosswise void filler for stretch wrapped loads only

**Diamond-Corr®**  
Void Filler

**Diamond-Corr®**  
Crosswise Center Void Filler

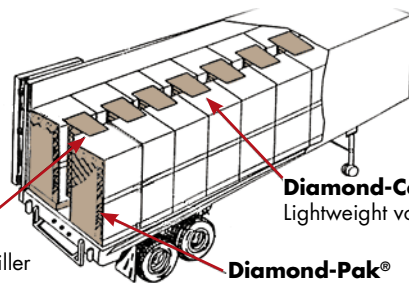

**Diamond-Corr®**  
Lightweight void fillers

**Diamond-Pak®**  
Bulkhead

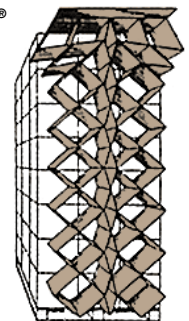

### Saddle-Pak®

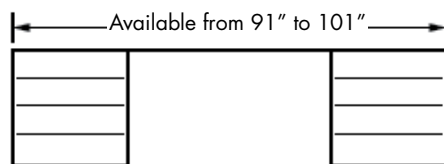

Available in widths  
from 21" to 28"

#### Benefits:

- For "singled out" units
- Maintain proper "axle weight"
- Prevents singles from "transit creep" to sidewall

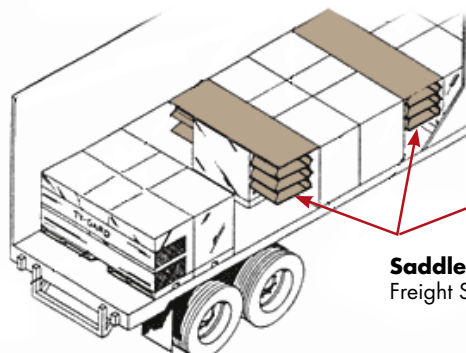

**Saddle-Pak®**  
Freight Shift Protection

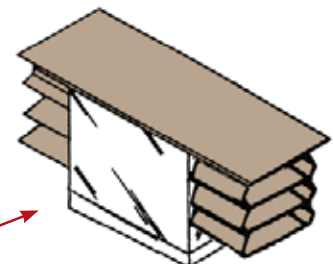

[www.tyogacontainer.com](http://www.tyogacontainer.com)

## Dunnage Air Bags



Dunnage air bags are used to restrain movement of cargo loads in trucks, overseas containers or railcars. They fill voids, brace loads, absorb vibrations and protect cargo from in-transit damage, better than any other form of bracing.

### Benefits:

**Safe:** International Dunnage bags are produced under ISO 9001 and 14001 standards and certified by the association of American Railroads (AAR) and the Railway Association of Canada (RAC). They are 100% leak proof tested before shipping.

### Cost Effective:

International Dunnage Airbags are inexpensive and reusable (for non-railroad use only).

### Lightweight & Water Proof:

International Dunnage bags are easy to handle, light in weight, takes up less space and are resistant to moisture and water ingress.

### Take Shape to Odd Configurations:

International Dunnage bags are flexible, allowing you the advantage of filling every shape and odd space without damaging your goods.

**Can Fill a Larger Void:** Due to their flexibility, International Dunnage bags can fill a space up to 18", much larger compared to the paper Dunnage bags which can only fill a void up to 14".

Licensed manufacturer for:



## Diamond-Pak® Bulkhead

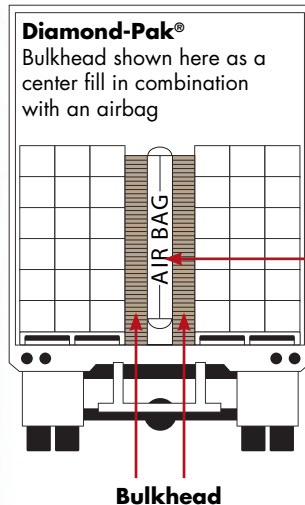

**Air-Bag**  
Disposable Inflatable  
Dunnage (DID)

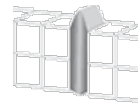

### Benefits:

- End to end filler for railcar loading
- Center filler used with Air-Bag

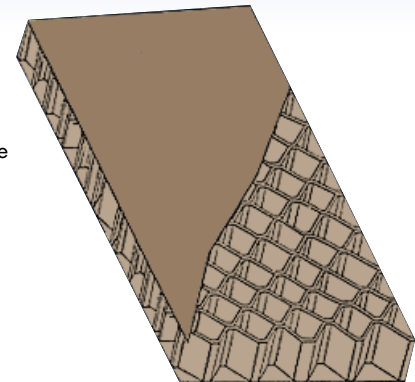

## Wood-Pak®

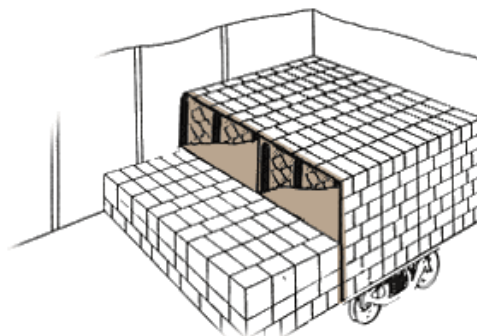

### Benefits:

- Secure incomplete layer of containers
- Can be used in lieu of plywood for stacking uneven load lengths
- Made with honeycomb and 1" x 4" boards to prevent toppling

## Match-Book®

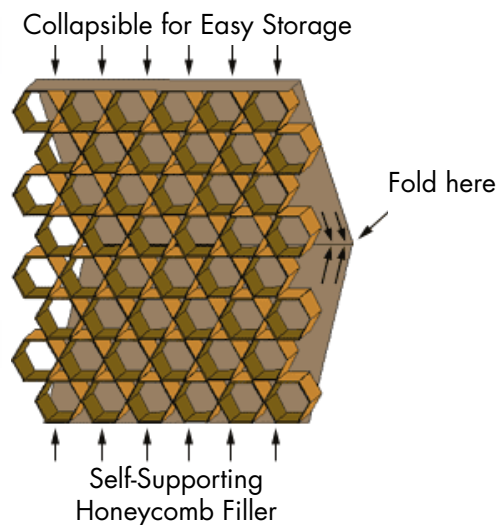

### Benefits:

- Foldable filler
- Space-saving



(800) 724-6003

[www.tyogacontainer.com](http://www.tyogacontainer.com)

CONTAINER COMPANY, INC.  
**Tyoga**